



INSTRUCTIONS

#82016 ZEX™ Nitrous Injection System

Thank you for choosing ZEX™ products; we are proud to be your manufacturer of choice. Please read this instruction sheet carefully before beginning installation, and also take a moment to review the included limited warranty information.



Description	Qty.	Description	Qty.
Nitrous Management Unit	1	Mounting Bolts and Nuts	1
10 lb. Nitrous Supply Bottle (unfilled)	1	Arming Switch/Wire Harness	1
4 ft. Stainless Steel Braided Hose, -3AN	1	Wire T-Taps	2
16 ft. Stainless Steel Braided Hose, -4AN	1	Barrel Connector	1
Nitrous Spray Nozzle	1	Spade Connector	1
Bulkhead Fitting Assembly	1	Ground Ring Terminal	1
1/16 NPT Tap	1	Black cable ties	10
3 ft. Length of Rubber Hose (3/16 SAE30R/KY)	2	Grommets	2
Hose Clamps	4	Instructions	1
Tall Bottle Bracket	1	32 Tuning Jet	1
Short Bottle Bracket	1	36 Tuning Jet	1

**NITROUS
HELP™**
888.817.1008

ZEX™
3418 Democrat Rd.
Memphis, TN 38118
Phone: 1-888-817-1008 Fax: (901) 375-3430
www.zex.com

Part #ZEX120
Revised 9/12/07

Quick Start Reference Guide:

- **What is nitrous oxide?** Nitrous oxide is a gas composed of two nitrogen atoms bonded to one oxygen atom. The scientific abbreviation for one nitrous oxide molecule is N_2O , where N is nitrogen and O is oxygen. This is where the familiar phrase “N-2-O” comes from when people talk about nitrous oxide.
- **How nitrous oxide makes power:** Nitrous oxide kits make large amounts of horsepower by allowing an engine to burn more fuel. Burning more fuel creates higher cylinder pressures that will push down on the pistons with greater force. When the nitrous is injected into an engine and the initial combustion takes place, it creates enough heat to separate the nitrous oxide into its two components, nitrogen and oxygen. Once separated, the additional oxygen is then free to react with additional fuel. To run nitrous successfully and safely, you have to introduce precise amounts of additional fuel with precise amounts of nitrous oxide. All of the extra oxygen provided by the nitrous oxide must have fuel to react, or you may damage your engine severely. When the amount of nitrous and the amount of supplemental fuel is controlled precisely, your engine can safely and reliably generate exceptional power increases.
- **Wet & dry nitrous systems:** A fuel injected dry manifold system uses a spray nozzle to deliver only nitrous oxide to the intake. A wet manifold system introduces fuel and nitrous into the intake manifold. With a dry manifold system, the additional fuel is supplied by increasing fuel delivery from the injectors when the nitrous system is activated. It is called a dry manifold system because there isn’t any fuel present in the intake manifold. The ZEX™ Nitrous System is a dry system.
- **Powerful features, plus it’s easy to use and install.** The ZEX™ Nitrous Oxide System automatically adjusts the amount of enrichment fuel in relation to the nitrous bottle pressure, thereby maintaining consistent nitrous to fuel ratios. The result is greater power and reliability at all bottle pressures. Our solenoid is more efficient and require far less current draw than our competitor’s kits. This reduces the chances of burnt wires, blown fuses, etc. from excessive solenoid current draw. Once armed, the ZEX™ Nitrous System is engaged at wide open throttle by an electronic switch that uses the engine’s throttle position sensor (TPS) circuit. Wiring the switch is easy – just tap the kit’s white wire into the TPS voltage output. Simple and reliable. It’s easy to install, with all the major components (solenoid, electronic throttle switch, and nitrous manifold) contained in an attractive enclosure with a pre-assembled wiring harness. It’s a “plug and play” installation.
- **How the ZEX™ Nitrous Oxide System works:** The ZEX™ Nitrous Oxide Injection Kit begins with a connection to a supply cylinder containing pressurized liquid nitrous oxide. This cylinder is connected by means of a delivery hose to a normally closed electric solenoid valve. This solenoid valve, which is attached to a manifold assembly, is engaged and disengaged via the TPS switch. The manifold assembly distributes the nitrous oxide to the engine’s air inlet and the kit’s supplemental fuel control circuit. The nitrous oxide that is delivered to the engine’s air inlet is conveyed via a delivery hose to an injection nozzle. The amount of nitrous oxide, which provides the oxygen required for the horsepower increase, is adjustable by means of a metering jet installed in the injection nozzle itself. The nitrous oxide that is distributed to the fuel control circuit passes through a small bleed orifice. This bleed orifice provides a reference source of bottle pressure and a controllable source of pressure to perform the needed function of fuel enrichment. Fuel enrichment occurs by conveying this source of pressure through a delivery hose to the vacuum port on the fuel pressure regulator. This source of pressure on the rubber diaphragm of the fuel pressure regulator causes an increase in fuel pressure. This increase in fuel pressure performs the function of adding fuel volume through the engine’s own injectors. The amount of additional fuel that is added can be changed by an adjustable metering jet in the fuel control circuit. This jet accomplished the task by controlling the amount of pressure allowed to build in the delivery hose to the fuel pressure regulator. The jet bleeds off excess pressure in the fuel control circuit and vents it through a delivery tube back to the intake manifold plenum.

- **Work safely.** Always wear eye protection and gloves when working with lines or hoses that contain pressurized nitrous oxide or fuel. Never transport nitrous cylinders loose in a trunk or the bed of a pick-up truck and especially **NOT** within a vehicle's interior whether the cylinder is empty or full. Always disconnect the ground side of the battery when working any electrical components.
- **Nitrous oxide will not fix problems you already have.** Before you install your nitrous system, be sure your engine is in good mechanical condition. Intermittent wiring problems, etc., can lead to erratic system performance and possible engine damage.
- **Never defeat the operation of the safety relief disc in the nitrous cylinder's valve stem.** It's required by law and is there for your safety. Never drill, machine, weld, deform, scratch, drop, or modify a nitrous oxide cylinder in **ANY** way whatsoever!
- **Never overfill nitrous cylinders.** That little bit extra will put you and others at risk of injury. More often than not, when the cylinder warms up, the pressure goes above the limit of the safety relief disc, and you lose all the nitrous you just paid for.
- **All the power comes from the fuel, not the nitrous.** Nitrous oxide is a simple tool that allows you to adjust how much and how quickly the engine burns the fuel. If the fuel isn't there, the power won't be either.
- **Avoid detonation at all times.** Nitrous oxide enhanced detonation is much more damaging than detonation that occurs when naturally aspirated. This is due to the increased amount of fuel available for releasing energy and the fact that more oxygen is present.
- **If, when your system is activated, something doesn't feel or sound right, BACKOFF!** If you hear any detonation or feel anything unusual, get off the throttle. It's a lot easier to check everything over than it is to just try to drive through it and damage expensive parts.
- **Don't activate or have the system activated when you hit the stock rev limiter.** The stock rev limiter is a fuel cutoff. If you cut fuel while you're injecting nitrous, you're instantly very lean. This momentary lean condition has the potential to cause engine damage.
- **Engine modifications:** The ZEX™ Nitrous System, out of the box, is designed to work as a bolt-on kit for stock or mildly modified vehicles. Mildly modified vehicles would include header upgrades, exhaust upgrades, air filter kits, etc. If major engine modifications have been performed, larger injectors and a fuel pump upgrade will be required for safe nitrous system operation. Major engine modifications would include turbochargers, superchargers, aftermarket cylinder heads, head porting, camshafts, intake manifolds, etc. Failure to upgrade the fuel system when using nitrous in these highly modified applications may cause serious lean conditions that can result in severe engine damage.
- **Spark plugs and nitrous performance:** Quite often, factory type, wide gap, projected nose spark plugs will produce a detonation condition after a few seconds of nitrous use. The detonation is not due to the heat range, it occurs because the ground strap of the spark plug becomes a glow plug instead of a spark plug. The ground strap is too long to dissipate the extra heat produced by a nitrous accelerated burn. The correct solution is to replace the plugs

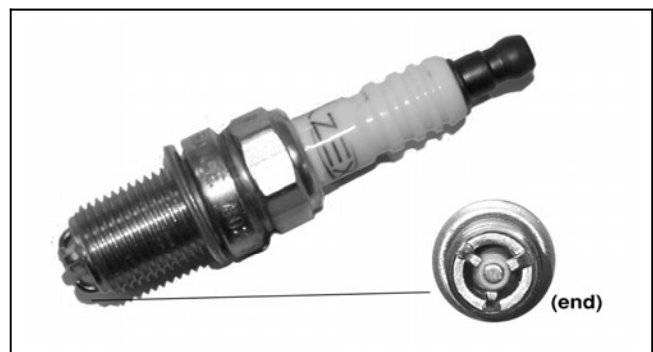

with units that have shorter ground straps. By doing this, you will shorten the heat path from the ground strap to the plug base. ZEX™ Hyperperformance Spark Plugs™ are recommended for many applications. ZEX™ Hyperperformance Spark Plugs™ are recommended for all nitrous oxide, turbocharged, and supercharged applications. This plug features three ground electrodes to ensure optimum spark energy and detonation resistance.

- **Reading plugs & tuning ZEX™ Nitrous Kit: If you've installed larger injectors or have otherwise increased the capacity of your fuel system, you need to read the following.** Because of the real limit of how much power you make with the ZEX™ Nitrous Kit is your car's fuel system, you need to tune up to that limit. Start with the lowest power level nitrous jet and corresponding fuel metering jet. Make a full throttle pass at the drag strip and read the plugs. Not enough nitrous/too much fuel results in a sooty,, black plug coloration. This coloration means that the fuel mixture is too rich. Too much nitrous will exhibit high heat in the form of a bluish or rainbow-like coloring on the plug's metal surfaces. This means your engine is about to, or is, detonating. If this is observed, ensure the proper spark plugs are installed, reduce nitrous/increase fuel delivery, and ensure the proper grade of fuel is being used.

When you check the spark plugs, check EVERY plug. Don't just sport check the easiest plug you can access. Due to the wide possibility of air/fuel mixture variations, you need to check every single plug for signs of detonation or other problems. If your plugs indicate too much fuel, trim the fuel delivery down by installing a larger metering jet. If you are too lean/not enough fuel, you need to install a smaller metering jet to increase fuel delivery.

- **Clear nitrous lines after use.** Close bottle valve. Use purge kit to relive pressure or open line fitting to let nitrous bleed off.

Installation Instructions:

1. **Decide where to put everything.** Before you drill a hole in your car, make sure you know where you're going to install the various components of this kit. You'll have to discover the best positions for each component by trial and error. First, the nitrous line that attaches to the engine air intake is about 4 ft. long. That means where you choose to install the nitrous nozzle decides, with a 4 ft. radius, where you have to mount the nitrous management unit (NMU). Also, you need to connect the vacuum/pressure circuit for the fuel pressure regulator to the NMU, so be aware of the distance between these components. You'll also have to decide where to install the arming switch and nitrous bottle. The arming switch should be installed in a position convenient to the driver, but not in an area that increases the chance of unintentionally arming the system. You'll have to run a wire through the firewall to the NMU. Do it just like you would run a lead for your stereo system. In fact, if you have one installed, you can probably run the arming lead through the same grommet. If not, try to use a wire loom hole that is grommeted. To help decide where you'll mount the nitrous supply bottle, check the following section for technical restrictions on bottle mounting locations and positions.
2. **Mount nitrous supply bottle.** Mount the nitrous supply bottle so that it is separated from the passenger cabin. Fastback style cars that do not have a separate trunk compartments have to be equipped with a safety blowdown tube. Route the tube from the safety pressure relief cap to the exterior of the car, preferably under the car. Doing so will prevent your car from filling with a cloud of nitrous oxide should the safety pressure relief cap rupture. Index the pickup tube with bottle position (Fig. 1, 2 and 3). ZEX™ nitrous bottles are designed with the bottom of the siphon tube at the bottom of the bottle towards the outlet. Always mount the bottle so that as your car accelerates, the liquid flows toward the pick-up tube.

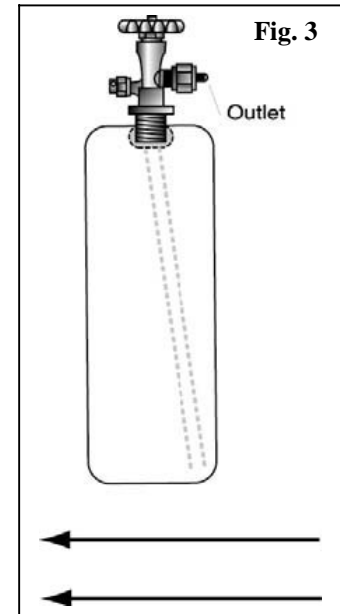
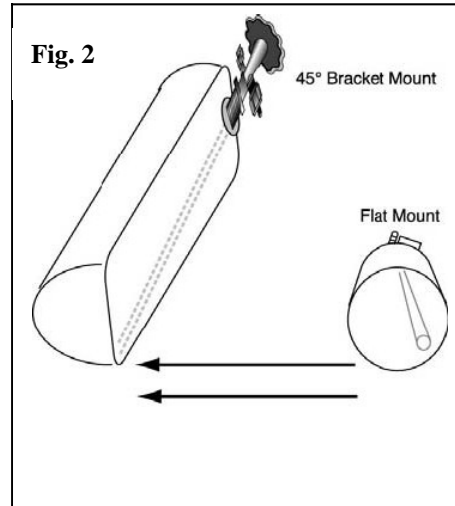
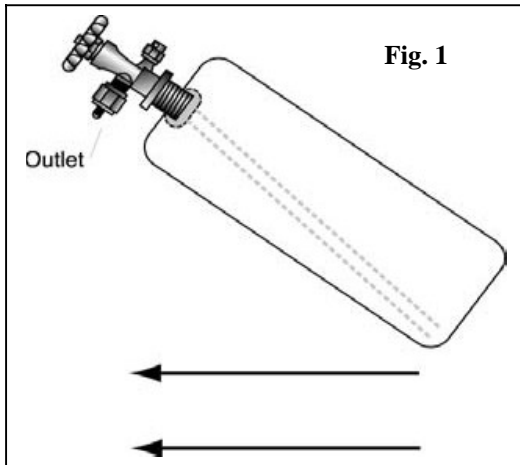

3. Mount nitrous delivery line under the car.

When routing the nitrous delivery line under the car, try to use the sub-frame as a conduit (Fig. 4). This protects the line and eliminates the need to use clamps. The supplied cable ties work if you can run the line higher in the under-body so that it's safe from the road level obstacles such as speed bumps. For the pro-race look, you can use steel loom clamps with rubber sheathing to fasten the line to the body.



4. Mount nitrous management unit. Keeping in mind the length restrictions of the nitrous nozzle feed lines, mount the Nitrous Management Unit in a suitable location. Use the four screw holes provided for this purpose. It's a pretty rugged piece of equipment that is built to withstand underhood temperatures as well as exposure to weather.

5. Install nitrous nozzle. Optimum nozzle placement is 6" to 18" from the throttle body. After you have determined where to mount the nitrous nozzle (Fig. 5) in the intake, make sure this location won't interfere with other components. If your engine uses a mass air flow sensor, mount the nozzle after the sensor but before the throttle body. After you've found the spot, mark it and remove the air inlet duct from your engine. Drill a 7/16-inch mounting hole and install the bulk head fitting. Be sure to remove any drill shavings since they can severely damage your engine. Install the nitrous nozzle so that the spray is in the direction of airflow. Also enclosed is a tap (Fig. 6) should you need to mount the nozzle in a metal duct. Just drill a 1/4-inch hole where you want to mount the nozzle, tap the hole and install the nozzle. Once installed, place the appropriate tuning jet in the nozzle and attach the 2-foot long, -3AN hose over the nozzle end.

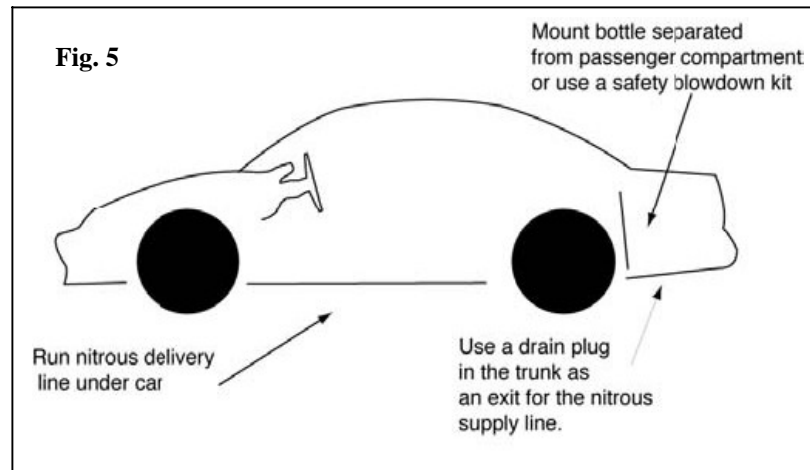

6. **Install regulator and intake hoses.** Measure and cut to length the two hoses that lead from the NMU's regulator and intake hose barb. The regulator hose barb from the UMU gets connected to the vacuum fitting on the engine's fuel pressure regulator with one of the lengths of hose. The intake hose barb from the NMU gets connected to an unused vacuum fitting coming off the intake manifold plenum with the other length of hose. Install the fuel tuning jet in the holder as seen in Fig. 8 and tighten the hose barb/tube nut assembly over the top of the jet.

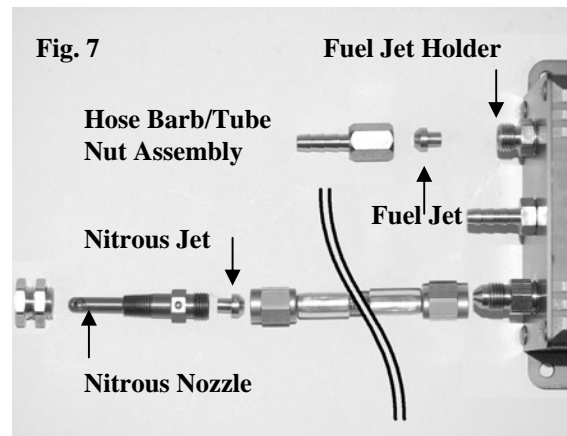
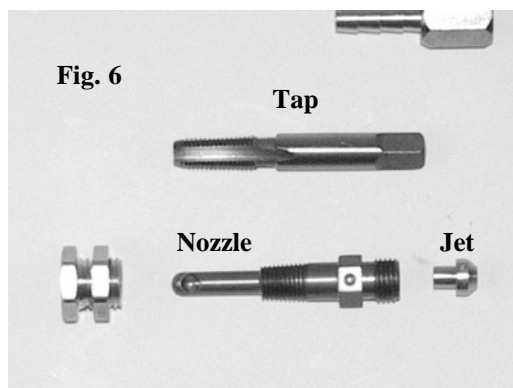

7. **Wire it.** Once you have mounted the components, you are ready to wire the nitrous system. From the Nitrous Management Unit, find a suitable ground for the black wire and connect to it with the included crimp-on ground ring. Run the red wire through the firewall of the vehicle into the interior, behind the dashboard. Ensure that the red wire passes through a grommeted hole and not a bare metal hole. The wire's insulation may be rubbed off if put through a nongrommeted hole. Run the white wire from the NMU to the output voltage lead from the throttle position sensor. After these connections are completed, you need to install the arming switch/wire harness assembly. Find a suitable place in the interior of the vehicle for the arming switch and drill a 1/2-inch (.500) hole. Mount the switch and switch cover through this hole. Take the lead that the fuse assembly is attached to and find a suitable 12 volt accessory source of power under the dash. Use the T-tap electrical connector to splice into the 12 volt accessory wire and plug in the wire harness lead. Take the other lead from the arming switch and connect it to the red wire from the Nitrous Management Unit. As a reference for wire locations, use Fig. 8.

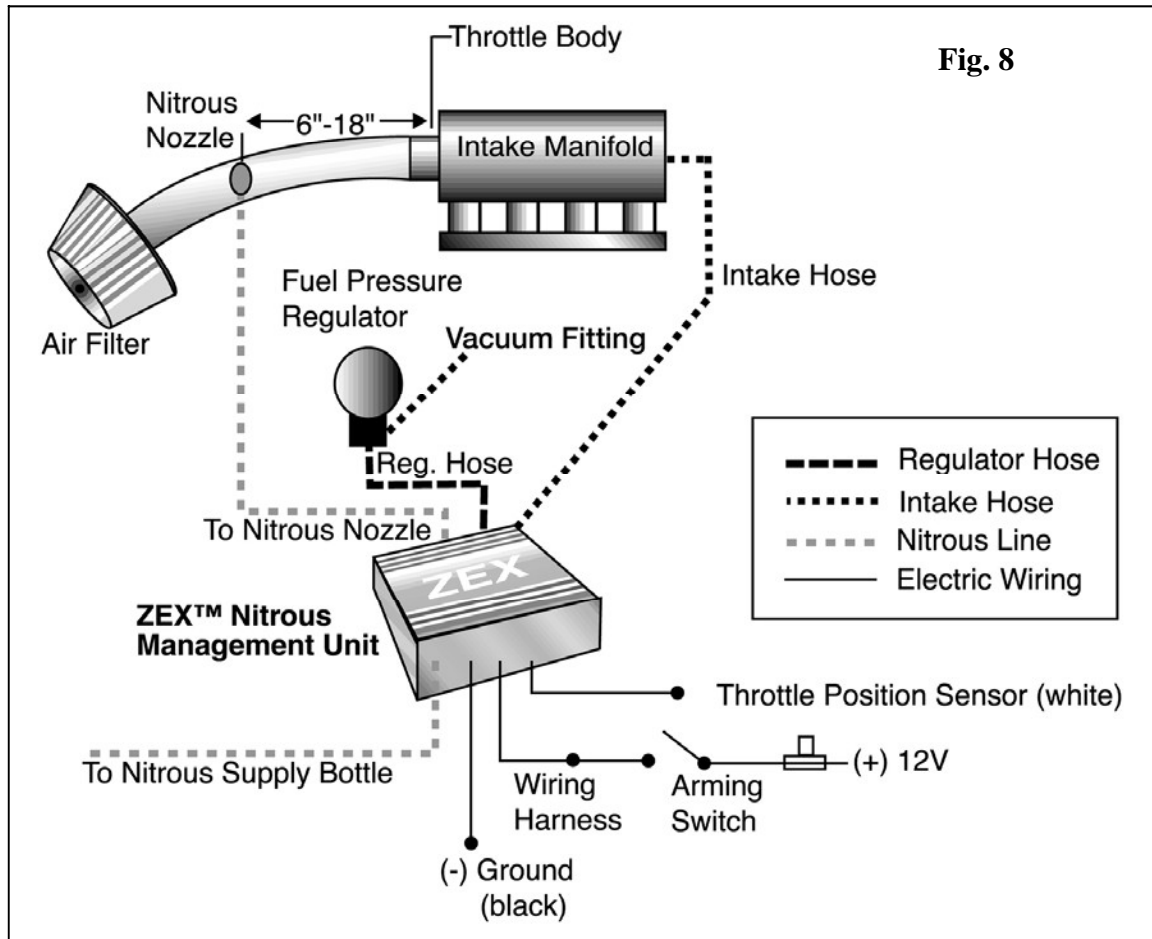

- 8. Program activation switch and check vacuum and pressure lines.** Now that you have completed the wiring of your nitrous kit, one of the final steps is to program the activation switch and check the vacuum and pressure lines. To program the Activation Switch, turn the vehicle's ignition on, but do not start the engine. Turn the nitrous arming switch to the "ON" position. Go to the Nitrous Management Unit (NMU) and locate the push-button switch. Depress, then release, the push-button switch. Observe the NMU's Operation Light. At this point, it should be RED. This RED light informs you that the NMU's Activation Switch is in learn mode. Return to the driver's seat and depress the accelerator pedal to the floor, holding it there for 10 seconds. Release the accelerator pedal and go back to the NMU and observe the Operation Light. At this point, the light should be flashing continuously from RED to GREEN to OFF. This is the NMU's way of telling you that it has successfully learned the voltage curve of your engine's throttle position sensor. Go back to the driver's compartment and turn off the system's arming switch, then turn it back on. Go back to the NMU and observe the Operation Light. It should be solid GREEN at this point. This informs you that the system is armed and ready to activate at wide-open throttle. Return to the driver's seat and depress and release the accelerator pedal several times. You should hear the solenoid click each time you reach wide-open throttle. At this point, your Activation Switch is fully programmed and ready for use. If you ever transfer your nitrous system to another vehicle, perform this same procedure on the new vehicle to "relearn" the NMU's Activation Switch. To ensure that the system is ready to be used, a final vacuum and pressure check of the system's hoses and lines must be done. With the engine running, check your "intake" and "regulator" hoses for any vacuum leaks. Generally a vacuum leak will cause the engine to run rough. Assuming the vacuum lines check out, open the nitrous bottle valve. Listen carefully to your engine as the valve is opened. You should not

hear a difference in idle speed or engine sound. If you notice either of these changes, call our NITROUS HELP™ line at 1-888-817-1008. If there is not change in idle speed or engine sound, shut the engine off at this time and inspect the nitrous pressure lines and fittings for leaks. Leaks in the nitrous supply line will be obvious because they will be covered with frost.

- 9. Check fuel quality and ignition timing.** The last thing to do before enjoying your new nitrous system is to ensure that premium fuel (92 R/M Octane or better) is in the fuel tank and that your ignition timing is set correctly. All recommended ignition timing retard amounts on the Tune-Up Sheet are calculated off of the base, stock ignition setting. It is important to set this with a timing gun before you use your nitrous system for the first time. Do not assume that it is set properly. If the ignition timing is not set correctly, severe engine damage may occur.

ZEX™ #82016 Tune-Up Sheet

	55 hp
Nitrous Jet	32
Fuel Jet	36
Ignition Retard (deg.)	0

Premium quality fuel, 92 R/M octane or better, is required at all times for safe operation of your ZEX™ Nitrous System.

Limited Warranty

ZEX™ warrants that all of its products are free from defects in material and workmanship, and against excessive wear for a period of (1) one year from the date of purchase. This **limited warranty** shall cover the original purchaser.

ZEX's obligation under this warranty is limited to the repair or replacement of its product. To make a warranty claim, the part must be returned within (1) one year of purchase to the address listed below, freight prepaid. Items covered under warranty will be returned to you freight collect.

It is the responsibility of the installer to ensure that all of the components are correct before installation. We assume no liability for any errors made in tolerances, component selection, or installation.

There is absolutely no warranty on the following:

- A) Any parts used in racing applications;
- B) Any product that has been physically altered, improperly installed or maintained;
- C) Any product used in improper applications, abused, or not used in conjunction with the proper parts.

There are no implied warranties of merchantability or fitness for a particular purpose. There are no warranties, which extend beyond the description of the face hereof. ZEX™ will not be responsible for incidental and consequential damages, property damage or personal injury damages to the extent permitted by law. Where required by law, implied warranties or merchantability and fitness are limited for a term of (1) one year from the date of original purchase.

This warranty gives you specific legal rights and you may also have other legal rights, which vary from state to state.